

145t SPREADER BEAM END CAPS

Maxirig
QUALITY LIFTING SOLUTIONS

Maxilug 145 allows users to create their own custom length spreader beam using these heavy duty end units.

Designed to accommodate readily available line pipe, Maxirig can supply the units as is, or, with various pipe lengths to facilitate lifts spans from 2m up to 13m.



**MODEL
MAXILUG145**

SPECIFICATION

Working Load Limit:	145t (at 60°) / 80t (at 90°)
Tare Weight:	0.210t (each) / 0.420t (per pair)
Lifting lugs (top) suit:	85t Grade S bow shackle
Load lugs (lower) suit:	85t Grade S bow shackle

ASSURANCE

Compliance Standard:	AS4991-2004
Proof load tested:	Yes
NDT Weld Inspection:	Yes
Standard Finish*:	Painted (G36 Green)

*Other colours/finishes available on request

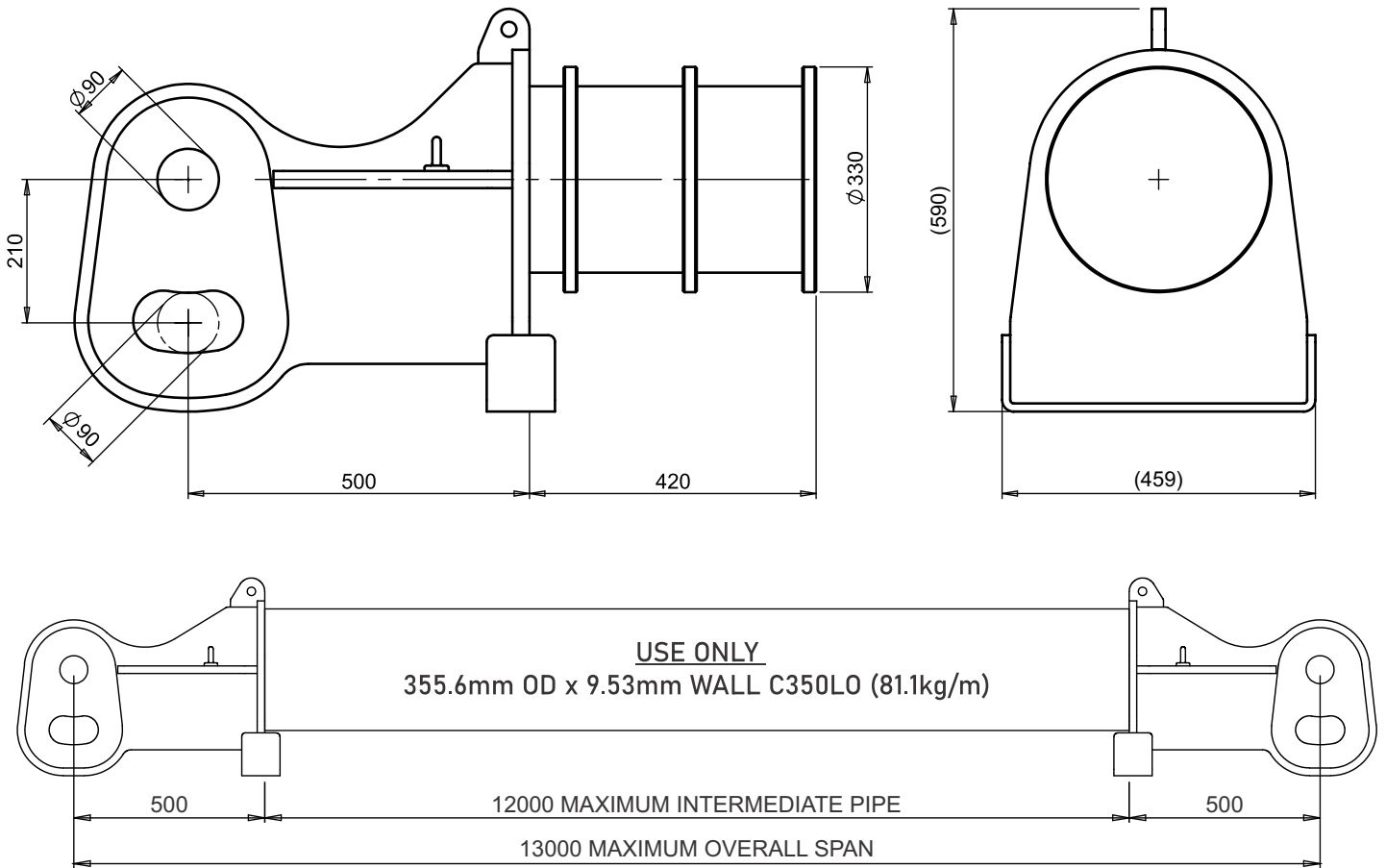

SUPERIOR QUALITY LIFTING PRODUCTS AUSTRALIA WIDE

All Maxirig products are designed and manufactured in Australia by our highly skilled team of engineers

maxirig.com.au