

20t EQUALIZER

Maxirig
QUALITY LIFTING SOLUTIONS

When using multi-point slings this device provides a means of equalizing load between sling legs.

Connection is made via standard Grade S bow shackles and can be used with chain, wire or synthetic slings.



MODEL
EQP1020

SPECIFICATION

Working Load Limit:	20 TONNE
Tare Weight:	0.025 TONNE
Lifting lug (top) suits:	25t Grade S bow shackle
Load lugs (lower) suit:	12t Grade S bow shackle

ASSURANCE

Compliance Standard:	AS4991-2004
Proof load tested:	Yes
NDT Weld Inspection:	Yes
Standard Finish*:	Painted (G36 Green)

*Other colours/finishes available on request

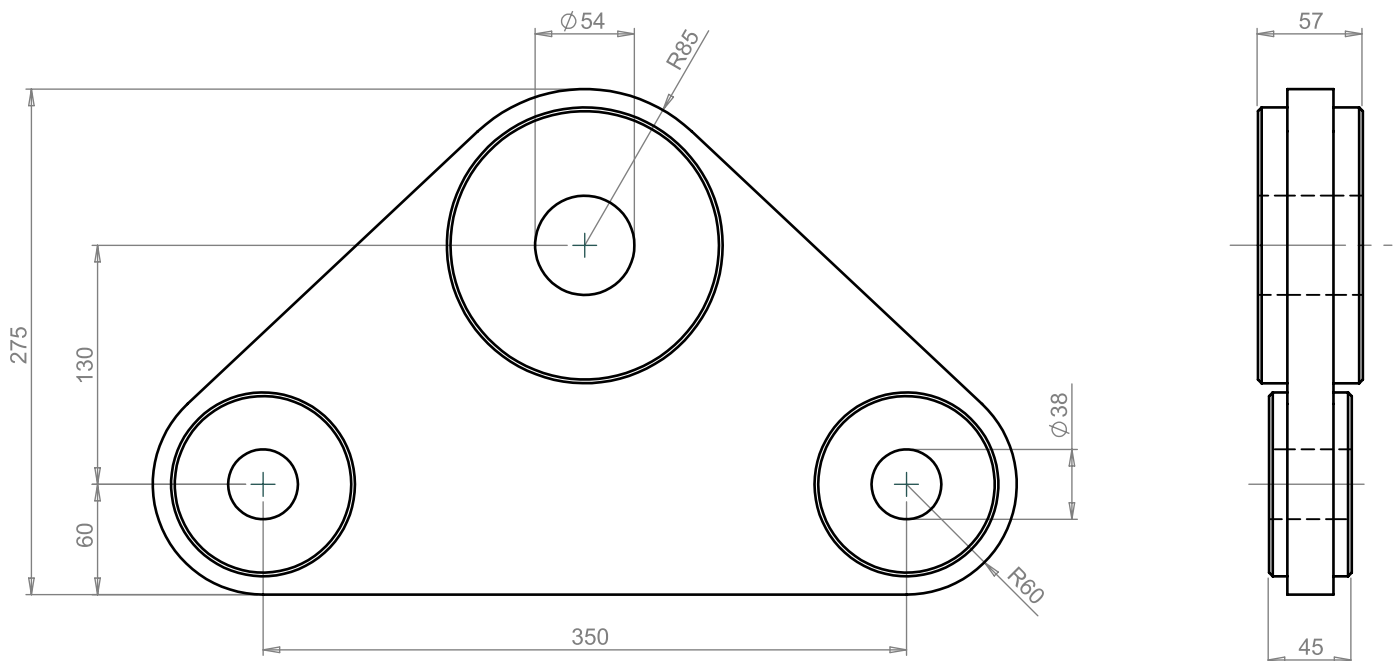

SUPERIOR QUALITY LIFTING PRODUCTS AUSTRALIA WIDE
All Maxirig products are designed and manufactured in Australia by our highly skilled team of engineers

maxirig.com.au